

# HUSKY 330



## Gebrauchsanleitung

Komfort-Schiebe-Befestigung  
mit Zentralverriegelung

## Instructions for use

Comfort sliding fitting  
with central locking system

## Instructions d'utilisation

Montage glissé facile  
avec verrouillage centralisé

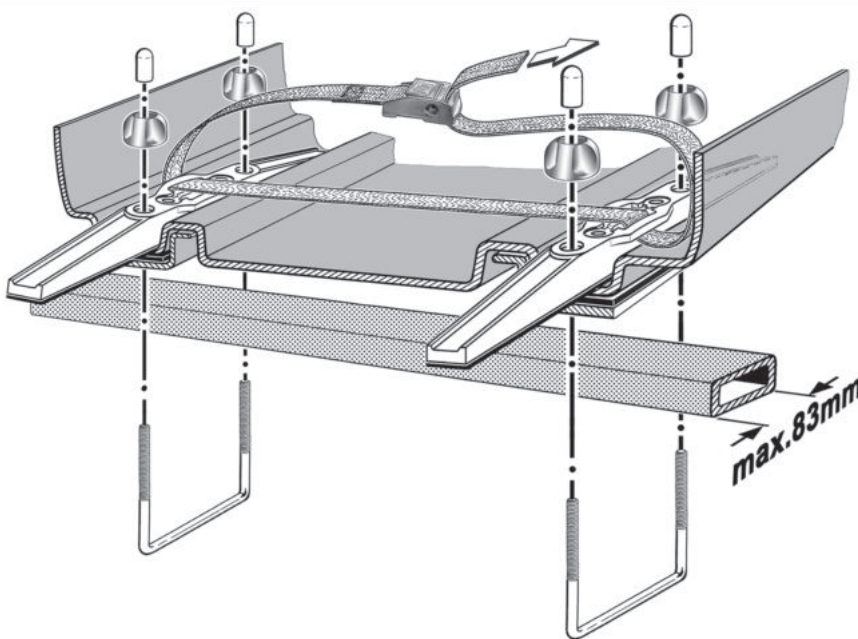
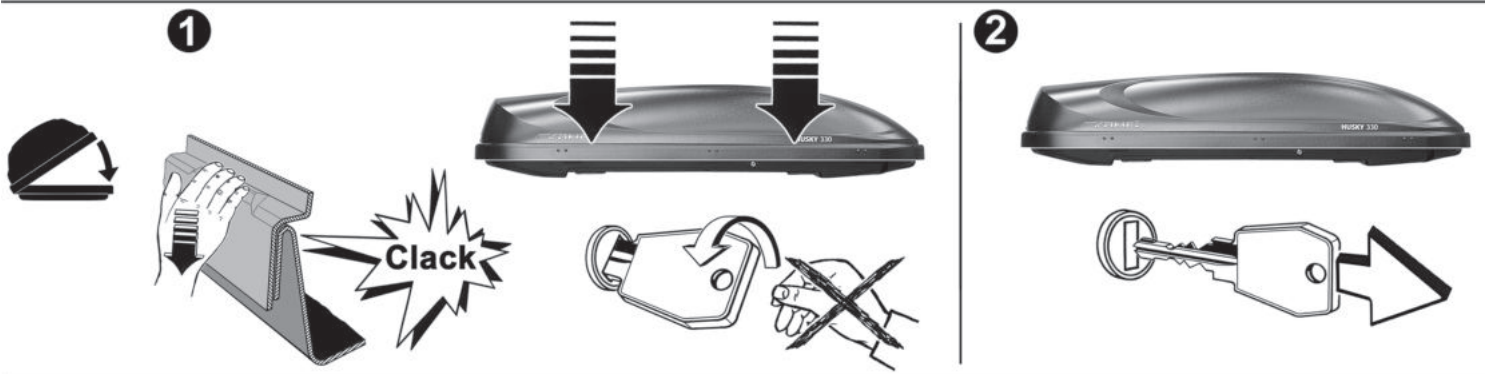
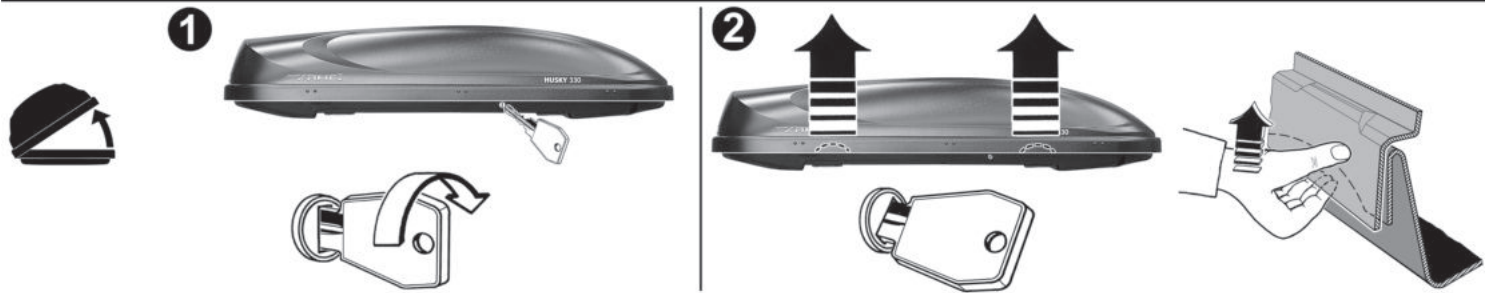
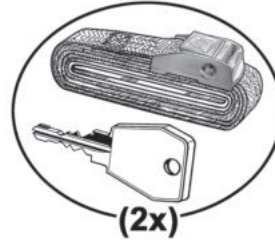
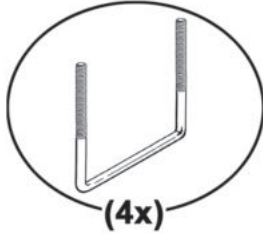

Art.-Nr. 0 52003 10  
0 52005 10

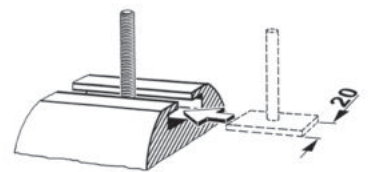

Art.-Nr. 0 52004 10

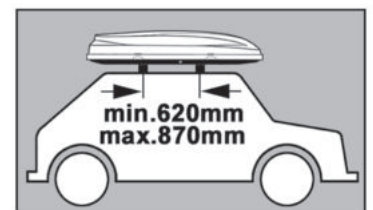
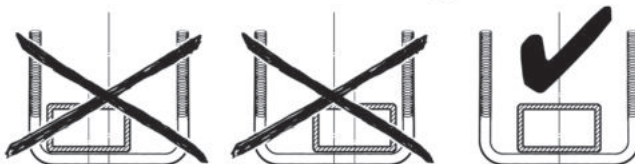
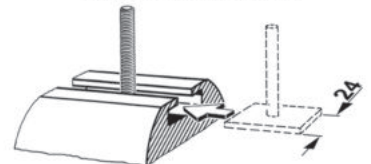

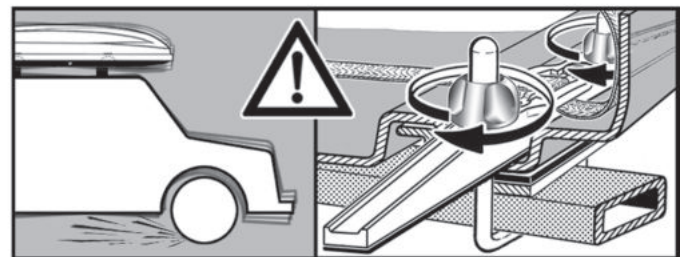
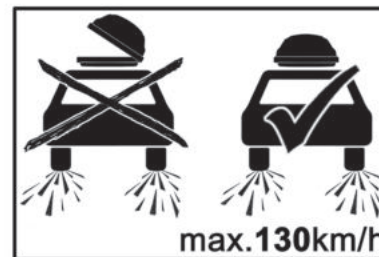
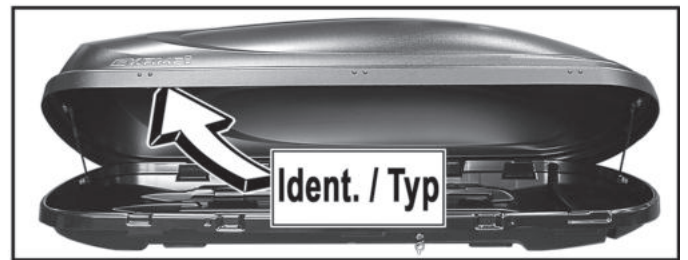
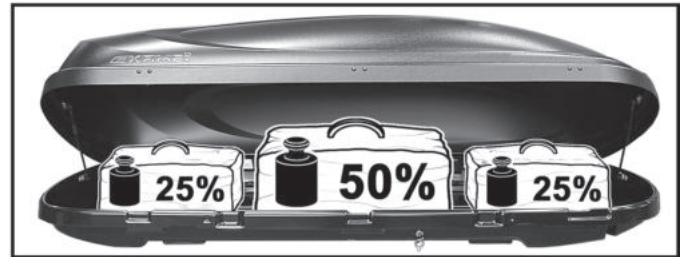
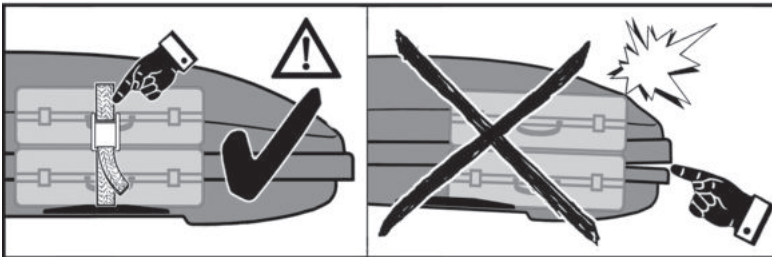
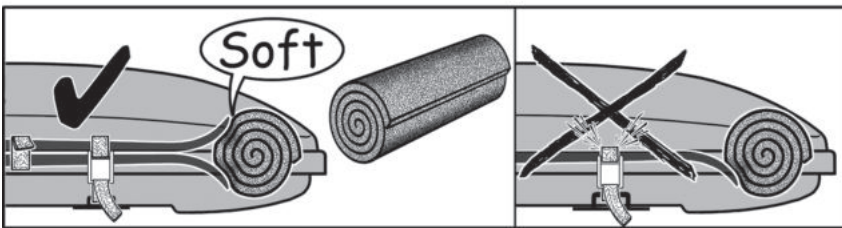
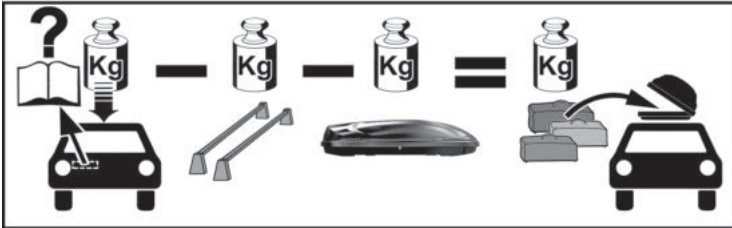
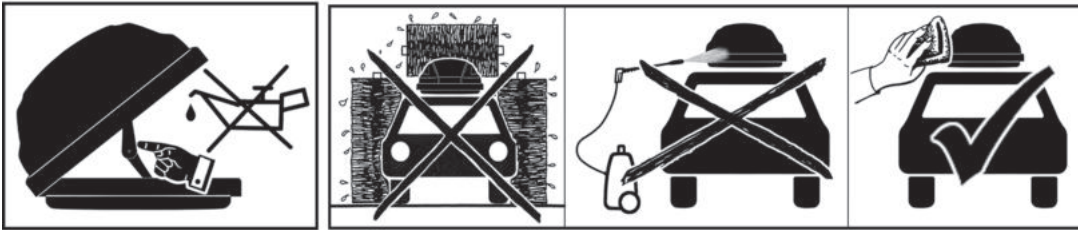
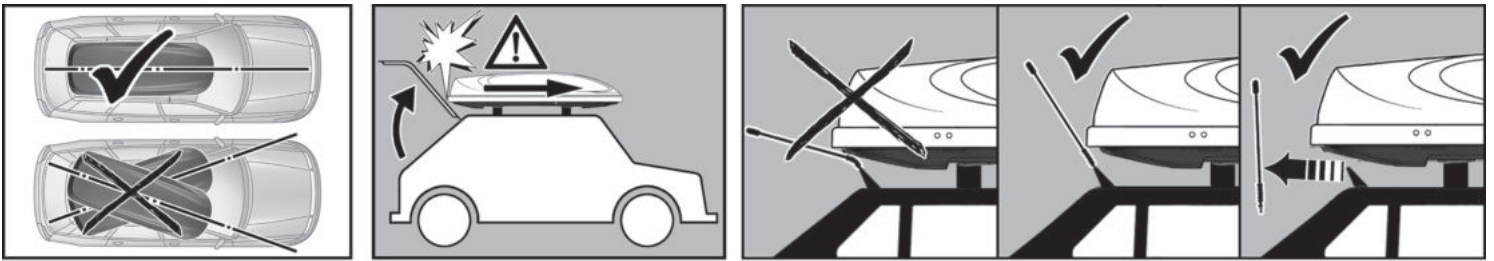

**Dachcontainer Typ 81200**

Haupt-Verkaufsbezeichnung Auch andere Verkaufsbezeichnungen sind genehmigt	Maße			Volumen Schüttgut Liter	Gewichte		
	Länge cm	Breite cm	Höhe cm		Eigengewicht kg	zulässige Tragfähigkeit kg	Maximalgewicht beladen kg
Husky 330 schwarz - matt	190	75	38	330	13	50	63
Husky 330 schwarz - hochglanz	190	75	38	330	15	50	65

Hersteller: KAMEI